

CENTURY SERIES  
KAYCAN

# Century Series Aluminum Flashing & Trim

SKU: KYC-CENTURY-FLASH

## WARRANTY

Lifetime Limited Warranty

Kaycan Century Series Aluminum Flashing & Trim covers every flashing and trim need for residential and light commercial exteriors. The collection spans natural aluminum angle flashings (2", 3", 4" legs), drip caps in three heights, step flashings in multiple sizes, aluminum rolls in standard mill finish (50' and 150') and pre-painted White or Chocolate (10' and 50'), plus a complete lineup of galvanized steel products including window and door flashings, drip edges, eaves starters, and galvanized rolls. All Kaycan aluminum products are coated with a proprietary Two-Coat system — thermo-setting acrylic primer and Polycoat 9000™ polyester topcoat, baked on and guaranteed not to flake or crack. Kaycan's coating has the lowest abrasive characteristic in the industry. Backed by a Lifetime Limited Warranty. Distributed in Canada by Kaycan.

## Key Features

- Natural aluminum, pre-painted aluminum, and galvanized steel in one collection
- Drip caps in 7/8", 1 3/8", and 1 3/4" sizes — aluminum and galvanized
- Aluminum rolls in standard mill finish — 50' and 150' lengths, plus 14"–20" Handy Rolls
- Galvanized window and door flashings in 1-1/4", 1-3/4", and 2-1/2" profiles
- Two-Coat Polycoat 9000™ finish — fade-resistant, guaranteed not to flake or crack
- Chrome-free processes, water-conservation and waste minimization programs
- Aluminum angle flashings in 2" x 2", 3" x 3", and 4" x 4" profiles
- Step flashings in multiple sizes — aluminum and galvanized
- Pre-painted aluminum rolls in White and Chocolate — 10' and 50' lengths, plus Handy Rolls
- Galvanized rolls in 6"–36" widths — 10' and 50' lengths
- Kaycan's coating has the lowest abrasive characteristic in the industry
- Backed by a Lifetime Limited Warranty

## Profiles & Specifications

ALU

Aluminum Products

1072

2" x 2" Angle Flashing

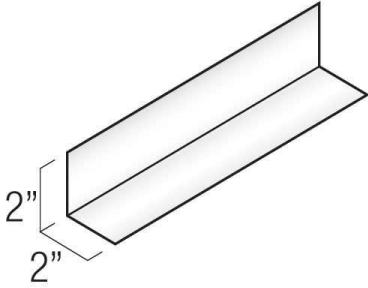

Length	10'
Qty / Ctn	10 pcs

1073

3" x 3" Angle Flashing

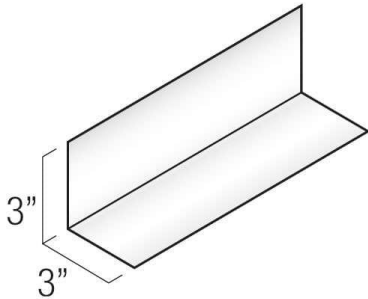

Length	10'
Qty / Ctn	10 pcs

1074

4" x 4" Angle Flashing

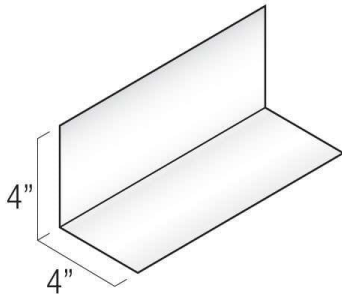

Length	10'
Qty / Ctn	10 pcs

1151

7/8" Drip Cap

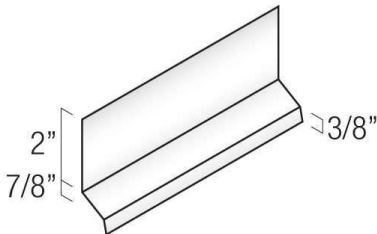

Length	10'
Qty / Ctn	25 pcs

1152

1 3/8" Drip Cap

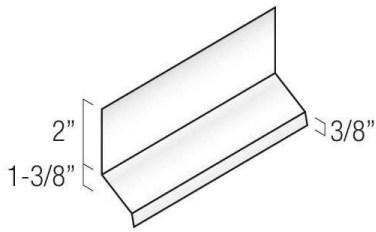

Length	10'
Qty / Ctn	25 pcs

1153

1 3/4" Drip Cap

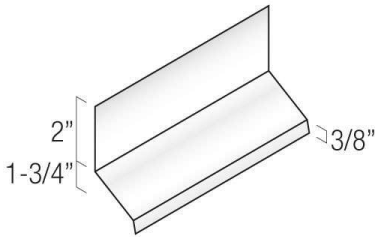

Length	10'
Qty / Ctn	25 pcs

1079

3" x 4" x 10 1/2" Step Flashing

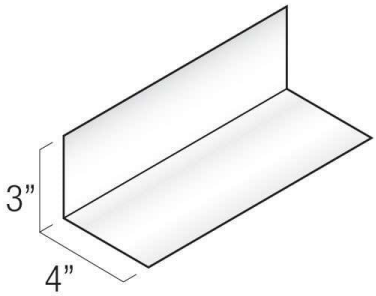

Length	10.5'
Qty / Ctn	100 pcs

107150

2 1/2" x 3 1/2" x 8 1/2" Step Flashing

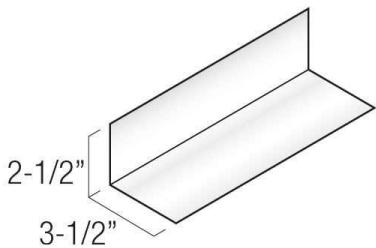

Length	6.5'
Qty / Ctn	100 pcs

**107800**

3 1/2" x 3 1/2" x 8 1/2" Step Flashing

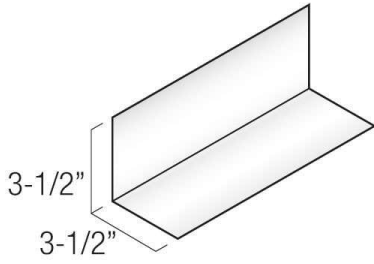

Length	8.5'
Qty / Ctn	12 pcs

**711100**

Anti-Rodent Trim Outside Corner

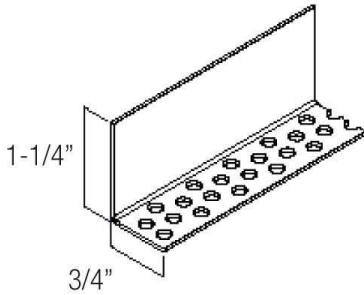

Length	9'-10"
Qty / Ctn	30 pcs

**GALV**

Galvanized Steel Products

**108000**

2" x 2" Angle Flashing

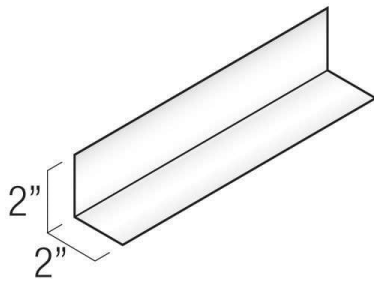

Length	10'
Qty / Ctn	10 pcs

**108050**

3" x 3" Angle Flashing

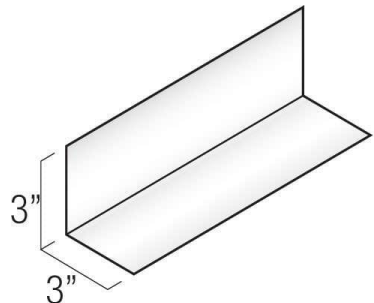

Length	10'
Qty / Ctn	10 pcs

108060

4" x 4" Angle Flashing

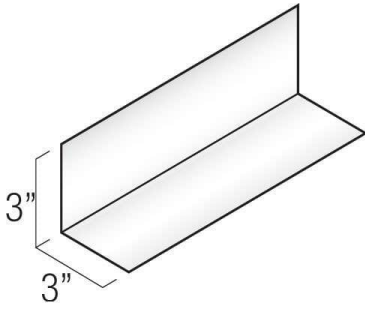

Length	10'
Qty / Ctn	10 pcs

115500

7/8" Drip Cap

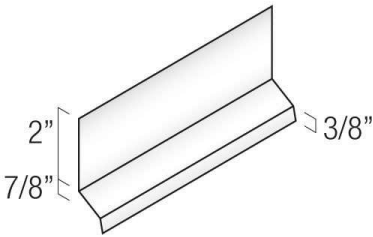

Length	10'
Qty / Ctn	10 pcs

115600

1 3/8" Drip Cap

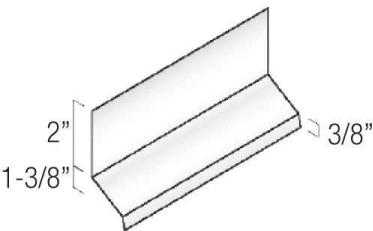

Length	10'
Qty / Ctn	10 pcs

115700

1 3/4" Drip Cap

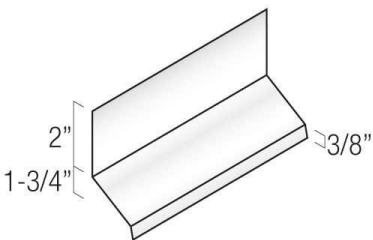

Length	10'
Qty / Ctn	10 pcs

**107900**

3" x 4" x 10 1/2" Step Flashing

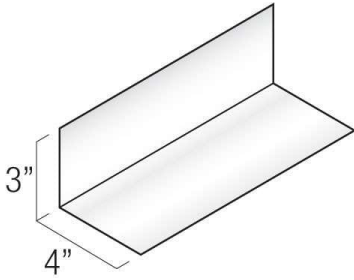

Length	10.5'
Qty / Ctn	10 pcs

**108400**

Eaves Starter

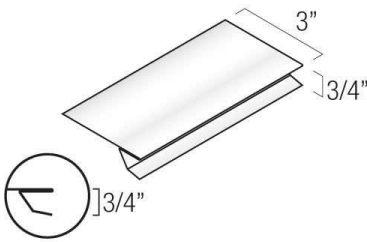

Length	9'-10"
Qty / Ctn	100 pcs

**116501**

1-1/4" Window and Door Flashing

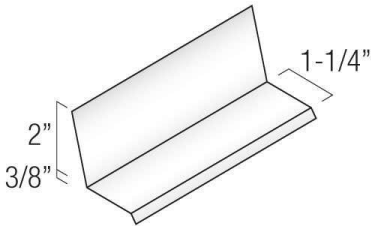

Length	10'
Qty / Ctn	10 pcs

**116601**

1-3/4" Window and Door Flashing

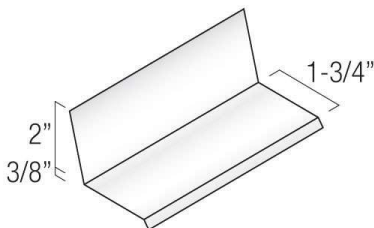

Length	10'
Qty / Ctn	10 pcs

116701

2-1/2" Window and Door Flashing

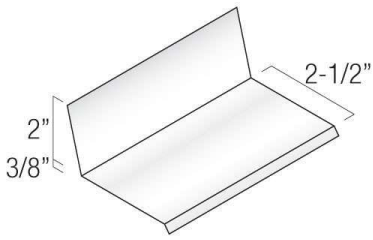

Length	10'
Qty / Ctn	10 pcs

9730

2-1/2" x 2-1/2" Drip Edge

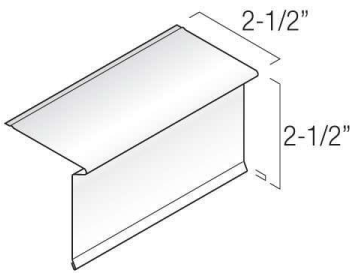

Length	10'
Qty / Ctn	20 pcs

711001

Anti-Rodent Trim

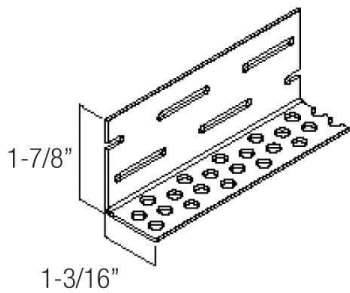

Length	8' 2"
Qty / Ctn	20 pcs

\* Vinyl material

ALU-ROLLS

Aluminum Rolls

073090

6"-36" x 50' Roll — Mill Finish



Item #(s)	073090, 073100, 073150, 073155, 073157, 073158
Available widths	6"-36"
Length	50'
Finish	Standard Mill Finish

**073159**

6"-36" x 150' Roll — Mill Finish

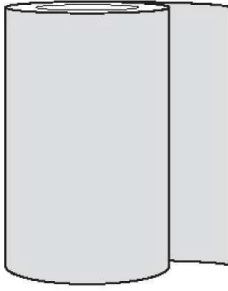

Item #(s)	073159, 073160, 073165, 073170, 073171, 073172
Available widths	6"-36"
Length	150'
Finish	Standard Mill Finish

**038000**

14"-20" x 10' Handy Roll — Mill Finish

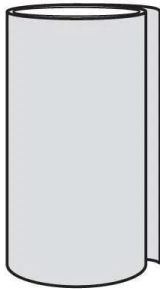

Item #(s)	038000, 038050
Available widths	14"-20"
Length	10'
Finish	Standard Mill Finish

\* Handy Roll

**038543**

6"-36" x 10' Roll — Pre-Painted



Item #(s)	038543, 038643, 038743, 038843, 038943, 039043
Available widths	6"-36"
Length	10'
Colours	White, Chocolate

**073243**

6"-36" x 50' Roll — Pre-Painted

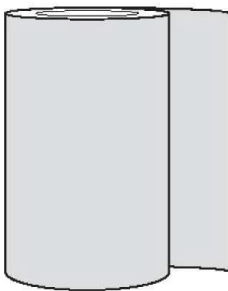

Item #(s)	073243, 073343, 073443, 073543, 073843, 073143
Available widths	6"-36"
Length	50'
Colours	White, Chocolate

**038001**

14"-20" x 10' Handy Roll — Pre-Painted

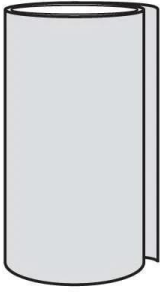

Item #(s)	038001, 038101
Available widths	14"-20"
Length	10'
Colours	White, Chocolate

\* Handy Roll

**GALV-ROLLS**

Galvanized Steel Rolls

**039100**

6"-36" x 10' Galvanized Roll

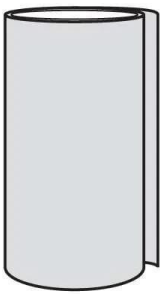

Item #(s)	039100 – 039600
Available widths	6"-36"
Length	10'

**070360**

6"-36" x 50' Galvanized Roll

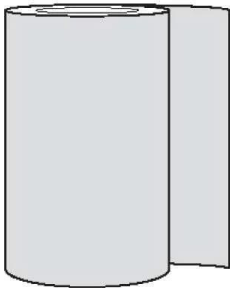

Item #(s)	070360 – 070470
Available widths	6"-36"
Length	50'



KAYCAN

## Ready to order?

Submit your spec list and we'll respond with pricing and availability - usually within one business day.

**WEB**

[promaterials.ca](http://promaterials.ca)

**PHONE**

(905) 836-7272

**EMAIL**

[info@promaterials.ca](mailto:info@promaterials.ca)

**ADDRESS**

Unit 5, 1235 Journey's End Cir, Newmarket, ON