

VINYL TRIMS
KAYCAN

Kaycan Vinyl Trims

SKU: KYC-VINYL-TRIMS

WARRANTY

Lifetime Limited Warranty for original homeowner

Kaycan Vinyl Trims provide everything needed to professionally finish a vinyl siding installation — from starter strips that lock the first course to decorative 6" insulated corner posts and architectural window surrounds. Built with Duratron™ Vinyl Technology and available in Kaycan's full colour palette, these trims are designed to coordinate seamlessly with Kaycan siding and soffit systems. All products are designed, developed, and manufactured in Canada.

Profiles & Specifications

GRP-GENERAL

General & Starter Trims

1066

Undersill Trim

Used to secure a cut vinyl siding panel underneath the bottom of a window and the top sheet on the house wall.

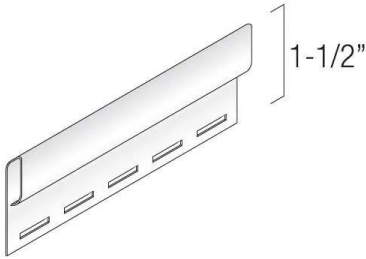

Length	12 2
Dimensions	1-1/2" height
Pcs/Carton	24

VT2DUT

Dual Undersill Trim

Double slot accepts a bevel or a dutch lap siding panel.

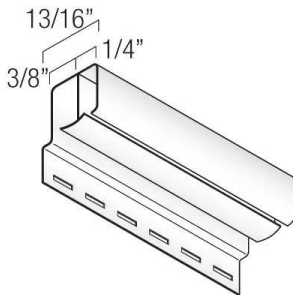

Length	12 2
Dimensions	3/8" face x 13/16" wide x 1/4" slot
Pcs/Carton	24

1175

Vertical Base Trim

Used for transition from horizontal to vertical siding. The vertical base trim locks to the horizontal siding.

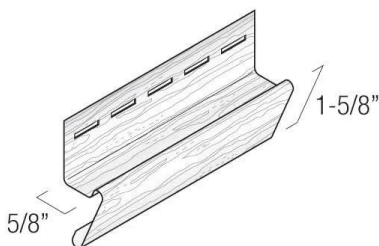

Length	12 2
Dimensions	5/8" channel x 1-5/8" face
Pcs/Carton	24

1035

1" J Trim

Standard trim used around doors and windows.

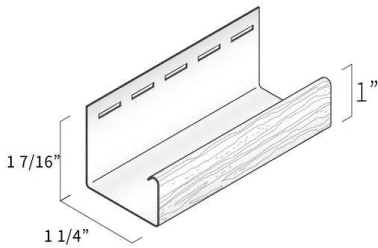

Length	12 2
Dimensions	1-7/16" height x 1-1/4" depth x 1" face
Pcs/Carton	40

1045

1 1/4" J Trim

Used for deeper profiled siding or when insulation is being used behind the siding.

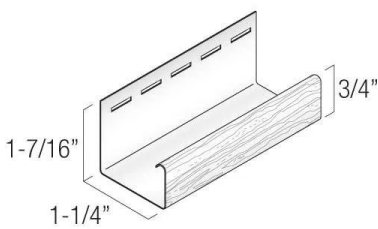

Length	12 2
Dimensions	1-7/16" height x 1-1/4" channel x 3/4" face
Pcs/Carton	24

1059

1 1/2" J Channel

Used when insulation is behind the siding.

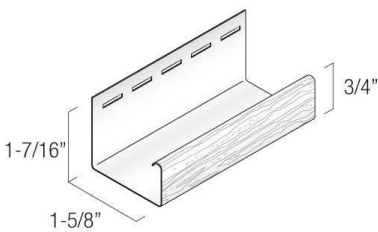

Length	12 2
Dimensions	1-7/16" height x 1-5/8" channel x 3/4" face
Pcs/Carton	24
Availability	White only

106201

Double 3 1/2" J Channel

'Belly trim' with 3 1/2" face and a built-in 'J' — used as a 3 1/2" band in a horizontal siding wall.

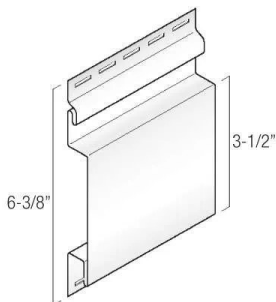

Length	20 2
Dimensions	3-1/2" face x 6-3/8" total height
Pcs/Carton	12

106301

Double 6" J Channel

'Belly trim' with 6" face and a built-in 'J' — used as a 6" band in a horizontal siding wall.

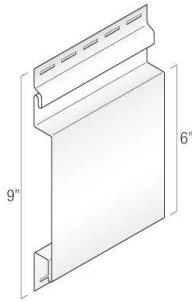

Length	20 2
Dimensions	6" face x 9" total height
Pcs/Carton	16

1085

Vinyl Starter Strip

Starter strip used to lock the first row of siding in place. Offers a positive lock.

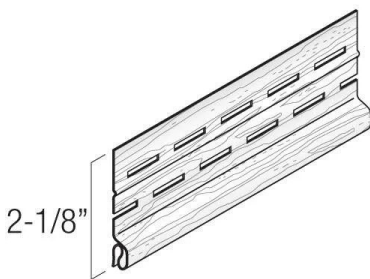

Length	12 2
Dimensions	2-1/8" height
Pcs/Carton	24

1082 / 1083

Kaylock Starter Strip

Metal starter strip used to lock the first row of siding in place. Offers a snap lock.

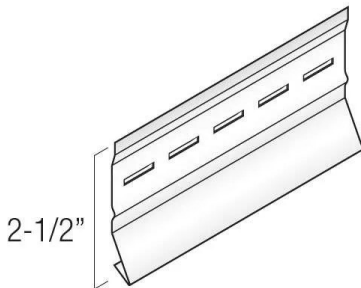

Length	10 2
Dimensions	2-1/2" height
Pcs/Carton	50 (1082) / 30 (1083)

GRP-SOFFIT

Soffit Trims

1178

F Trim

Trims with a 1/2" wide channel, used at the top of the wall and on the bottom of the fascia board to insert soffit.

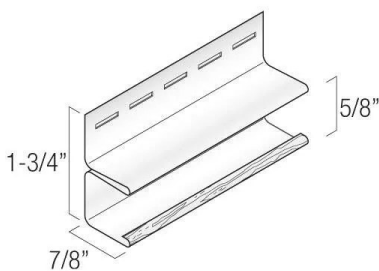

Length	12 2
Dimensions	5/8" channel x 1-3/4" face depth x 7/8" bottom
Pcs/Carton	28

1179

H Trim

Used to add a break in a wall or ceiling of vertical siding and soffit.

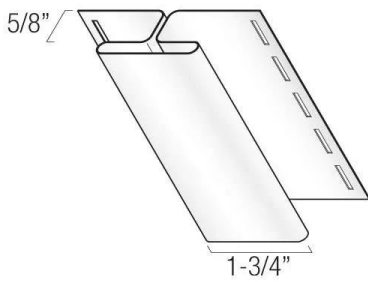

Length	12 2
Dimensions	5/8" height x 1-3/4" width
Pcs/Carton	12

0490 / 0494

8" Vinyl Fascia

8" vinyl fascia used to finish the exterior of the structure with integrated 1 1/2" wide channel for soffit. The fascia can be cut down to fit various structure heights.

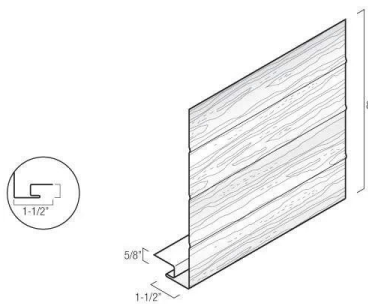

Length	9 2–10 2
Dimensions	8" face x 5/8" soffit channel x 1-1/2" bottom return
Pcs/Carton	16 (0490) / 24 (0494)

VTFBR

Frieze Trim

Can be used in combination with the Large Crown Mold. The top channel of the frieze is designed to accommodate the soffit, while the Large Crown Mold snaps into the bottom channel and covers the top of the siding wall and undersill trim.

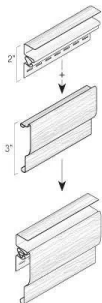

Length	12 2
Dimensions	2" face
Pcs/Carton	48

VTCMD

Large Crown Mold

Used in combination with the Frieze Trim — snaps into the bottom of the Frieze Trim and covers the top of the siding wall and undersill trim.

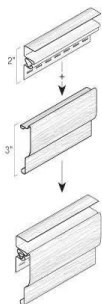

Length	12 2
Dimensions	3" face
Pcs/Carton	48

GRP-CORNER

Corner Post Trims

1105

3" Outside Corner Post

Corner piece with two 3" faces and two 3/4" wide channels to insert siding.

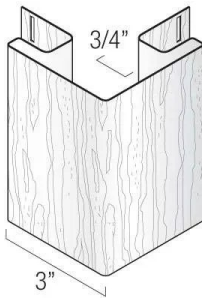

Length	10 2
Dimensions	3/4" nail flange x 3" face
Pcs/Carton	10

1109

2" Outside Corner Post

Corner piece with two 2" faces and two 1/2" wide channels to insert siding.

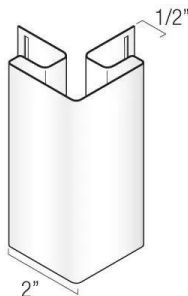

Length	10 2
Dimensions	1/2" nail flange x 2" face
Pcs/Carton	14

1104

4" Outside Corner Post

Corner piece with two 4" faces and two 1-1/4" wide channels to insert Ocean Park™ siding.

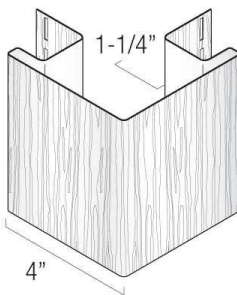

Length	10 2
Dimensions	1-1/4" nail flange x 4" face
Pcs/Carton	14

1107

6" Designer Corner Post

Corner piece with two 6" ribbed faces and two 5/8" wide channels for siding.

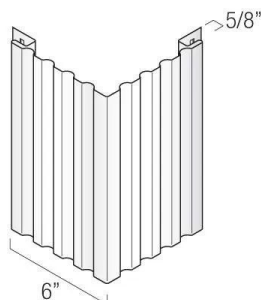

Length	20 2
Dimensions	5/8" nail flange x 6" face
Pcs/Carton	10

1132

6" Insulated Designer Corner Post

Corner piece with two 6" ribbed faces and two 3/4" wide channels for siding. Includes 6" Designer Outside Corner and insulated contoured foam.

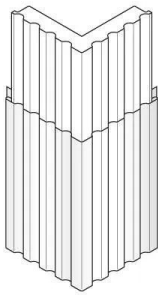

Length	20 2
Pcs/Carton	5

1250

6" Traditional Corner Post

Decorative corner piece with two 6" faces with setbacks and two 3/4" wide side channels for siding.

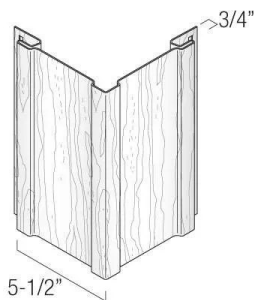

Length	18 2-6 2
Dimensions	3/4" nail flange x 5-1/2" face
Pcs/Carton	10

1253

6" Insulated Traditional Corner Post

Decorative corner piece with two 6" faces with setbacks and two 3/4" wide side channels for siding. Includes 6" Traditional Outside Corner and insulated contoured foam.

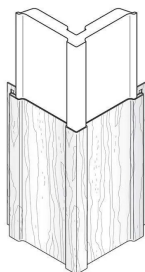

Length	20 2
Pcs/Carton	5

1115

Inside Corner Post

Inside corner post with one 3/8" face and two 1/2" wide channels for siding.

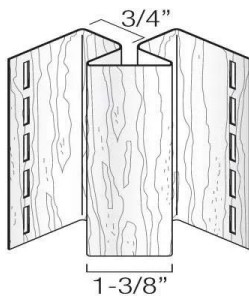

Length	10 2
Dimensions	3/4" nail flange x 1-3/8" total width
Pcs/Carton	24

1053 / 1054 / 1055

5-Piece Cove Corner

Cove corner made with five trims: two Window Starter trims (1054), two 5" Window Surround trims (1055), and one Corner Cove Insert (1053). Used together to produce a decorative cove corner detail.

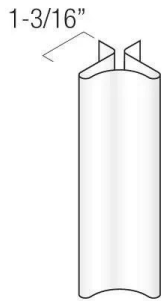

Length	12 2
Dimensions	1-3/16" cove insert width
Pcs/Carton	16 (1053) / 24 (1054) / 24 (1055)

1174

Bay/Bow Outside Corner Post

Corner piece with two 1" wide channels for siding. Used when installing siding with bay or bow windows.

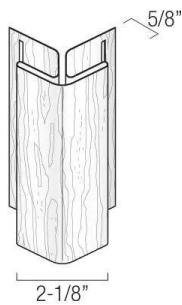

Length	10 2
Dimensions	5/8" nail flange x 2-1/8" face
Pcs/Carton	20

1173

Bay/Bow Inside Corner Post

Inside corner piece with two 1" wide channels for siding. Used when installing siding with bay or bow windows.

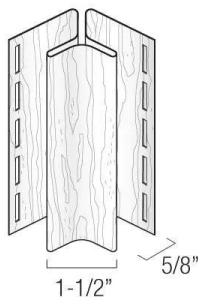

Length	10 2
Dimensions	5/8" nail flange x 1-1/2" face
Pcs/Carton	20

GRP-WINDOW

Window Trims

1056

Super J Trim

Trim used to create architectural details around doors and windows.

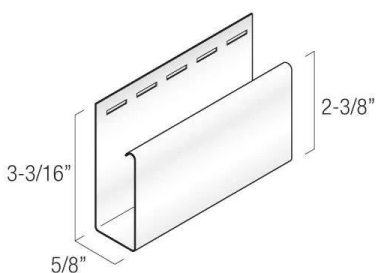

Length	12 2
Dimensions	2-3/8" nail flange x 3-3/16" total depth x 5/8" pocket
Pcs/Carton	12

1030

1½" Deep Pocket J Trim

Trim used to create architectural details around doors and windows.

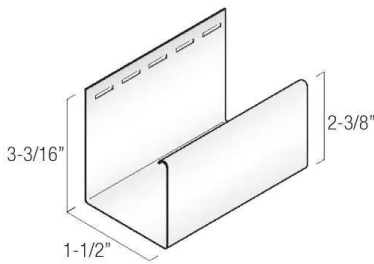

Length	12 2
Dimensions	2-3/8" nail flange x 3-3/16" total depth x 1-1/2" pocket
Pcs/Carton	18

1052

3½" Window Surround

Trim used with the Window Starter trim to create a wide band around windows.

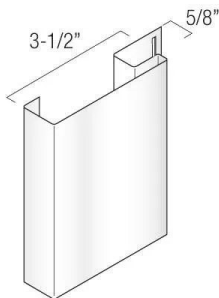

Length	12 2
Dimensions	3-1/2" wide x 5/8" nail flange
Pcs/Carton	36

1055

5" Window Surround

Trim used with the Window Starter trim to create a wide band around windows.

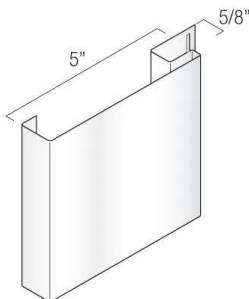

Length	12 2
Dimensions	5" wide x 5/8" nail flange
Pcs/Carton	24

1054

Window Starter

Trim used to anchor window surround trims.

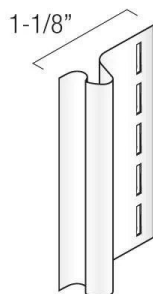

Length	12 2
Dimensions	1-1/8" wide
Pcs/Carton	24

1066

Undersill Trim

Trim used over windows to allow water to flow away from the wall. Also used to secure a cut vinyl siding panel underneath the bottom of a window.

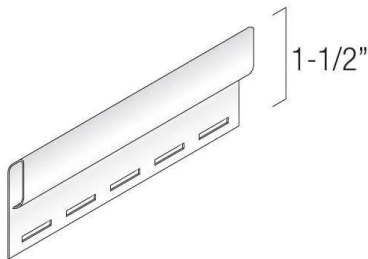

Length	12 2
Dimensions	1-1/2" height
Pcs/Carton	24

2095

1" Flexible J Trim

Trim used around window tops and shaped windows.

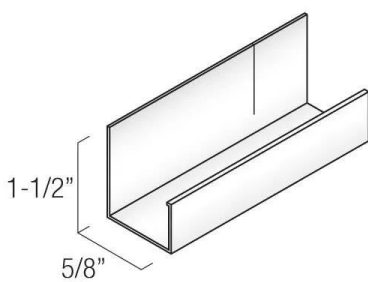

Length	12 2
Dimensions	1-1/2" height x 5/8" pocket
Pcs/Carton	18
Availability	White only

1185

Drip Cap

Used above windows and doors for water management.

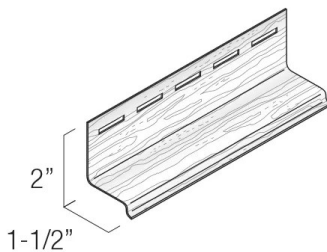

Length	12 2
Dimensions	2" vertical x 1-1/2" horizontal return
Pcs/Carton	24

Certifications & Testing Standards

Kaycan Vinyl Trims meets or exceeds the following Canadian and international performance standards.

- Duratron™ Vinyl Technology — ensures durability and long lasting performance
- Designed, developed and manufactured in Canada

Installation Guide

Critical Installation Rules

- 1 Available in a wide palette of colours to match Kaycan vinyl siding.
- 2 Not all colours are available in all profiles — contact your local Kaycan representative for specific availability.
- 3 1!J" J Channel (1059) available in white only.
- 4 1!J" Flexible J Trim (2095) available in white only.

- 5 Choosing a contrasting trim colour adds a bolder accent to your home's personality; matching the siding colour creates the appearance of a larger home.



KAYCAN

Ready to order?

Submit your spec list and we'll respond with pricing and availability - usually within one business day.

WEB

promaterials.ca

PHONE

(905) 836-7272

EMAIL

info@promaterials.ca

ADDRESS

Unit 5, 1235 Journey's End Cir, Newmarket, ON